

UNCONTROLLED DOCUMENT

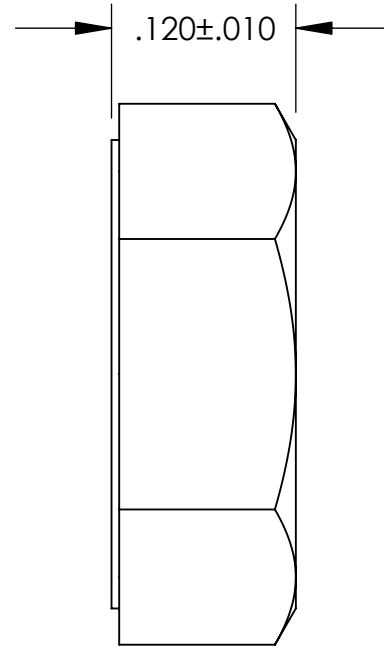
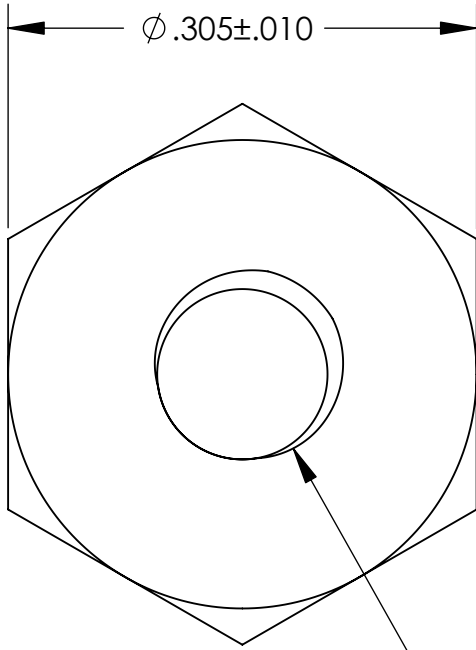

6-40 THREADS

TOLERANCES UNLESS NOTED

- $\pm .005$ ON DIMENSIONS THRU $.625$
- $\pm .008$ ON DIMENSIONS $.626$ THRU 1.000
- $\pm .010$ ON DIMENSIONS 1.001 THRU 1.500
- $\pm .015$ ON DIMENSIONS LARGER THAN 1.500
- $\pm .015$ ON FRACTIONAL DIMENSIONS

WE RESERVE THE RIGHT TO DISCONTINUE ITEMS, CHANGE SPECIFICATIONS OR DESIGN AT ANY TIME WITHOUT NOTICE AND WITHOUT INCURRING ANY OBLIGATIONS

PROPERTY OF
MICRO PLASTICS INC.

CATALOG DRAWING
NYLON HEX NUTS
MICRO P/N 0400640HN
DWG. # 0400640HN
FILE SERVER\ENG\WEB

MATERIAL: NYLON 6/6

DATE

SCALE
8:1

SD