

**UNCONTROLLED DOCUMENT**

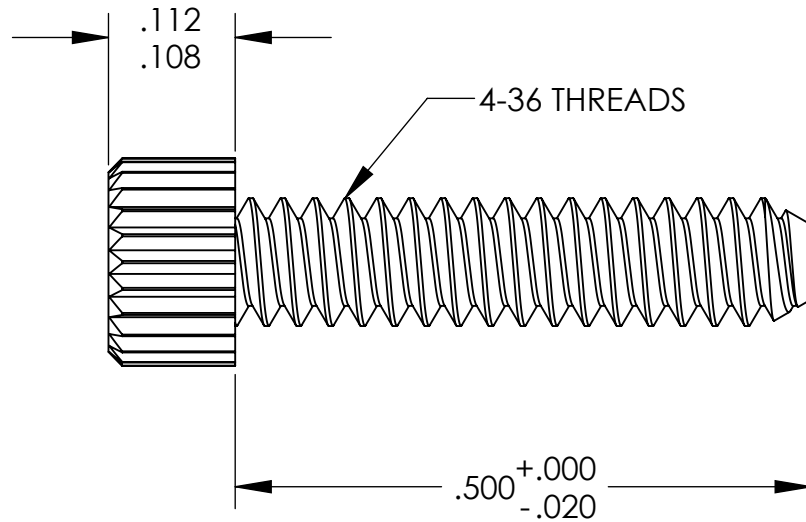
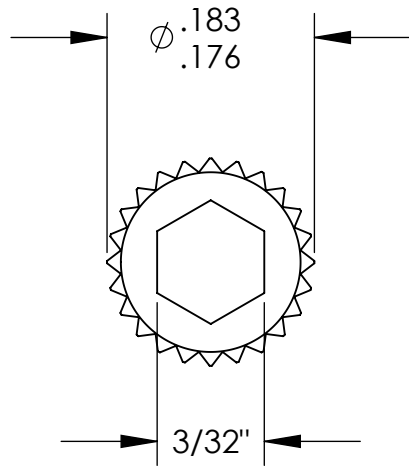

NOTES:  
.051 MINIMUM KEY ENGAGEMENT

TOLERANCES UNLESS NOTED

- ±.005 ON DIMENSIONS THRU .625
- ±.008 ON DIMENSIONS .626 THRU 1.000
- ±.010 ON DIMENSIONS 1.001 THRU 1.500
- ±.015 ON DIMENSIONS LARGER THAN 1.500
- ±.015 ON FRACTIONAL DIMENSIONS

**WE RESERVE THE RIGHT  
TO DISCONTINUE ITEMS,  
CHANGE SPECIFICATIONS  
OR DESIGN AT ANY TIME  
WITHOUT NOTICE AND  
WITHOUT INCURRING  
ANY OBLIGATIONS**

PROPERTY OF		
<b>MICRO PLASTICS INC.</b>		
CATALOG DRAWING HEX SOCKET CAP MACHINE SCREW MICRO P/N 3404360050 DWG. # 3404360050 FILE SERVER\ENG\WEB		
MATERIAL:		6/6 NYLON
DATE	SCALE	<b>JDD</b>
	6:1	