

UNCONTROLLED DOCUMENT

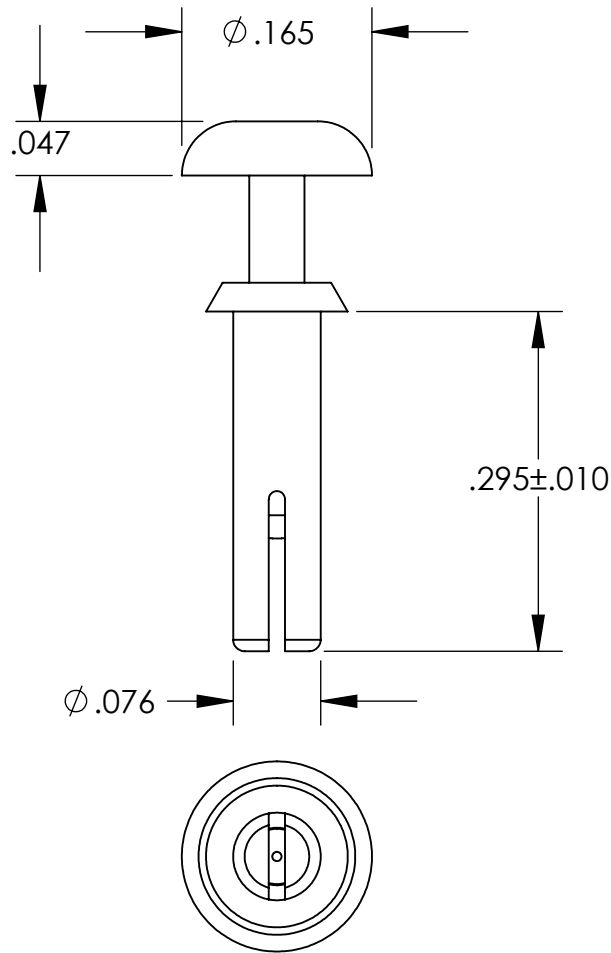

NOTES:
HOLE SIZE .083 / .087
PANEL THICKNESS .205 / .225

TOLERANCES UNLESS NOTED

- $\pm .005$ ON DIMENSIONS THRU $.625$
- $\pm .008$ ON DIMENSIONS $.626$ THRU 1.000
- $\pm .010$ ON DIMENSIONS 1.001 THRU 1.500
- $\pm .015$ ON DIMENSIONS LARGER THAN 1.500
- $\pm .015$ ON FRACTIONAL DIMENSIONS

WE RESERVE THE RIGHT
TO DISCONTINUE ITEMS,
CHANGE SPECIFICATIONS
OR DESIGN AT ANY TIME
WITHOUT NOTICE AND
WITHOUT INCURRING
ANY OBLIGATIONS

PROPERTY OF
MICRO PLASTICS INC.

CATALOG DRAWING
SNAP RIVET
MICRO P/N 27SR079295
DWG. # 27SR079295
FILE SERVER\ENG\WEB

MATERIAL: NYLON 6/6; BLACK

DATE

SCALE
6:1

TA