

UNCONTROLLED DOCUMENT

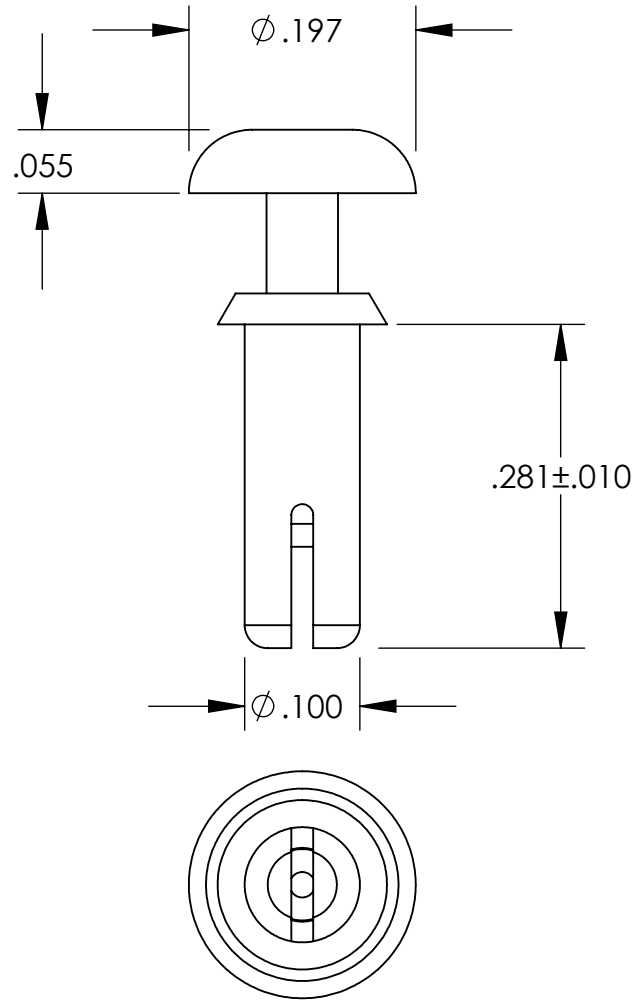

NOTES:
 HOLE SIZE .102 / .106
 PANEL THICKNESS .170 / .229

TOLERANCES UNLESS NOTED

- $\pm .005$ ON DIMENSIONS THRU $.625$
- $\pm .008$ ON DIMENSIONS $.626$ THRU 1.000
- $\pm .010$ ON DIMENSIONS 1.001 THRU 1.500
- $\pm .015$ ON DIMENSIONS LARGER THAN 1.500
- $\pm .015$ ON FRACTIONAL DIMENSIONS

WE RESERVE THE RIGHT
 TO DISCONTINUE ITEMS,
 CHANGE SPECIFICATIONS
 OR DESIGN AT ANY TIME
 WITHOUT NOTICE AND
 WITHOUT INCURRING
 ANY OBLIGATIONS

PROPERTY OF		
MICRO PLASTICS INC.		
CATALOG DRAWING SNAP RIVET MICRO P/N 27SR102280 DWG. # 27SR102280 FILE SERVER\ENG\WEB		
MATERIAL:	NYLON 6/6; BLACK	
DATE	SCALE 6:1	TA