

UNCONTROLLED DOCUMENT

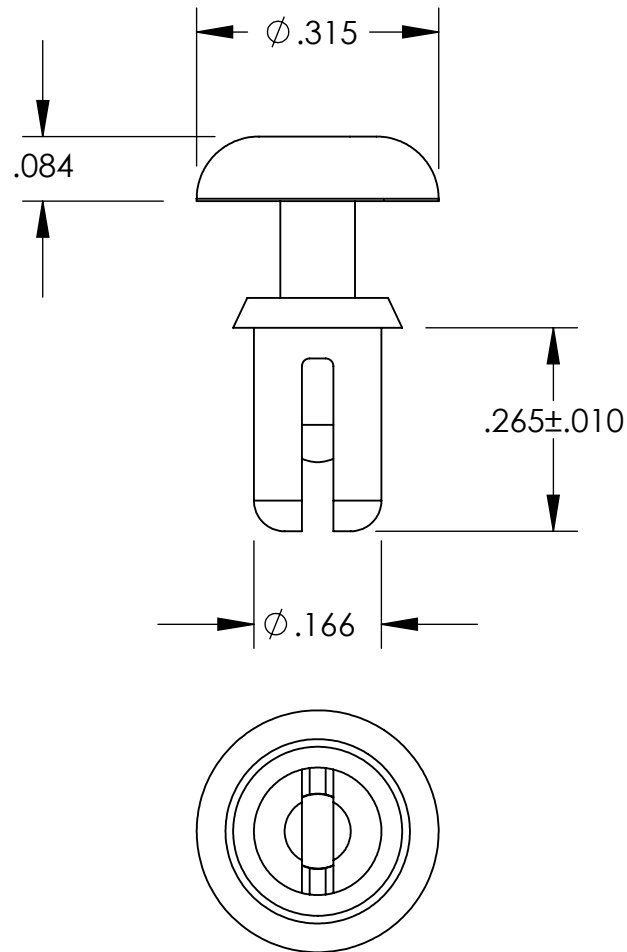

NOTES:
HOLE SIZE .171 / .175
PANEL THICKNESS .170 / .210

TOLERANCES UNLESS NOTED

- $\pm .005$ ON DIMENSIONS THRU $.625$
- $\pm .008$ ON DIMENSIONS $.626$ THRU 1.000
- $\pm .010$ ON DIMENSIONS 1.001 THRU 1.500
- $\pm .015$ ON DIMENSIONS LARGER THAN 1.500
- $\pm .015$ ON FRACTIONAL DIMENSIONS

WE RESERVE THE RIGHT
TO DISCONTINUE ITEMS,
CHANGE SPECIFICATIONS
OR DESIGN AT ANY TIME
WITHOUT NOTICE AND
WITHOUT INCURRING
ANY OBLIGATIONS

PROPERTY OF
MICRO PLASTICS INC.

CATALOG DRAWING
SNAP RIVET
MICRO P/N 27SR1660265
DWG. # 27SR1660265
FILE SERVER\ENG\WEB

MATERIAL: NYLON 6/6; BLACK

DATE

SCALE
4:1

TA