

UNCONTROLLED DOCUMENT

NOTES:
HOLE SIZE .187 / .191
PANEL THICKNESS .250 / .437

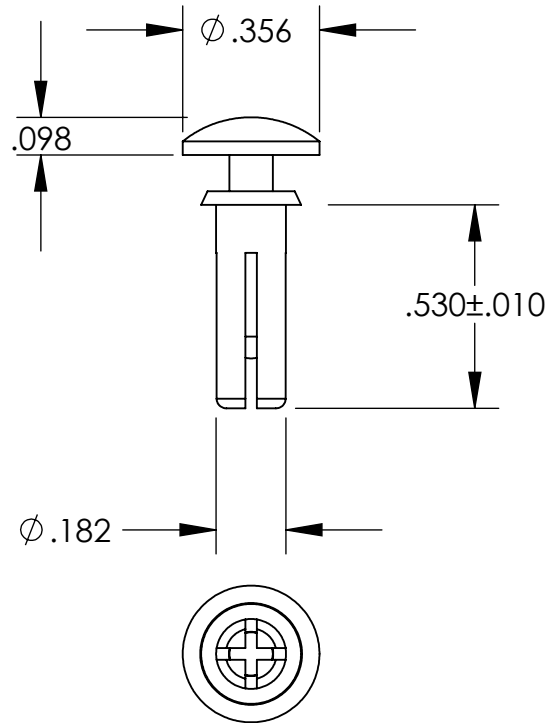

TOLERANCES UNLESS NOTED

- $\pm .005$ ON DIMENSIONS THRU $.625$
- $\pm .008$ ON DIMENSIONS $.626$ THRU 1.000
- $\pm .010$ ON DIMENSIONS 1.001 THRU 1.500
- $\pm .015$ ON DIMENSIONS LARGER THAN 1.500
- $\pm .015$ ON FRACTIONAL DIMENSIONS

WE RESERVE THE RIGHT
TO DISCONTINUE ITEMS,
CHANGE SPECIFICATIONS
OR DESIGN AT ANY TIME
WITHOUT NOTICE AND
WITHOUT INCURRING
ANY OBLIGATIONS

PROPERTY OF
MICRO PLASTICS INC.

CATALOG DRAWING
SNAP RIVET
MICRO P/N 27SR180530
DWG. # 27SR180530
FILE SERVER\ENG\WEB

MATERIAL: NYLON 6/6; BLACK

DATE

SCALE
2:1

TA