

UNCONTROLLED DOCUMENT

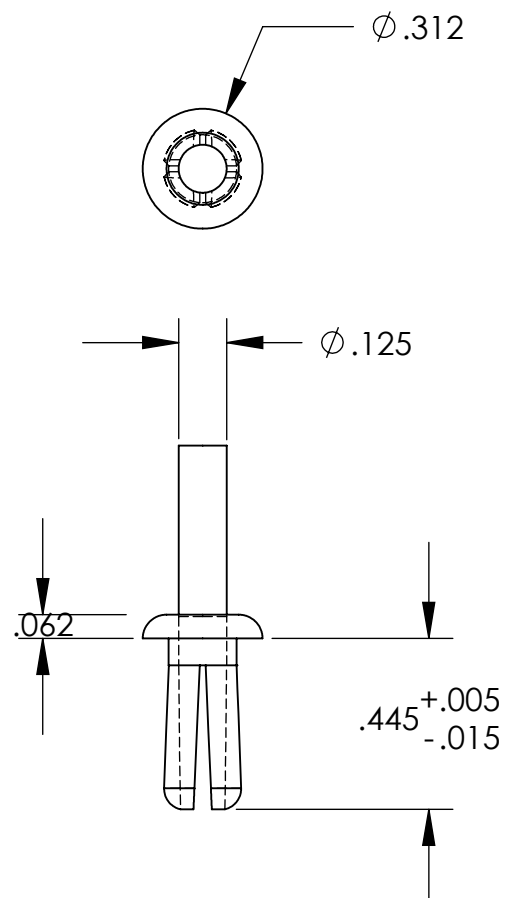

NOTES:
 HOLE SIZE - .187
 PANEL THICKNESS - .078 / .375
 HEAD STYLE - BINDER

TOLERANCES UNLESS NOTED

- $\pm .005$ ON DIMENSIONS THRU $.625$
- $\pm .008$ ON DIMENSIONS $.626$ THRU 1.000
- $\pm .010$ ON DIMENSIONS 1.001 THRU 1.500
- $\pm .015$ ON DIMENSIONS LARGER THAN 1.500
- $\pm .015$ ON FRACTIONAL DIMENSIONS

WE RESERVE THE RIGHT
 TO DISCONTINUE ITEMS,
 CHANGE SPECIFICATIONS
 OR DESIGN AT ANY TIME
 WITHOUT NOTICE AND
 WITHOUT INCURRING
 ANY OBLIGATIONS

PROPERTY OF		
MICRO PLASTICS INC.		
CATALOG DRAWING POLY DRIVE RIVET MICRO P/N 61PR400600 DWG. # 61PR400600 FILE SERVER\ENG\WEB		
MATERIAL:		NYLON 6/6
DATE	SCALE 2:1	TA