

**UNCONTROLLED DOCUMENT**

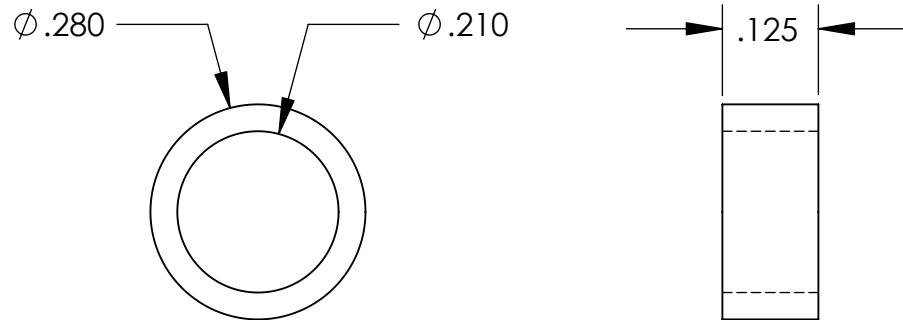

TOLERANCES UNLESS NOTED

- $\pm .005$  ON DIMENSIONS THRU  $.625$
- $\pm .008$  ON DIMENSIONS  $.626$  THRU  $1.000$
- $\pm .010$  ON DIMENSIONS  $1.001$  THRU  $1.500$
- $\pm .015$  ON DIMENSIONS LARGER THAN  $1.500$
- $\pm .015$  ON FRACTIONAL DIMENSIONS

**WE RESERVE THE RIGHT  
TO DISCONTINUE ITEMS,  
CHANGE SPECIFICATIONS  
OR DESIGN AT ANY TIME  
WITHOUT NOTICE AND  
WITHOUT INCURRING  
ANY OBLIGATIONS**

PROPERTY OF		
<b>MICRO PLASTICS INC.</b>		
CATALOG DRAWING SPECIAL FLAT WASHER MICRO P/N 17W02781 DWG. # 17W02781 FILE SERVER\ENG\WEB		
MATERIAL:		6/6 NYLON
DATE	SCALE	<b>TA</b>
	4:1	