

UNCONTROLLED DOCUMENT

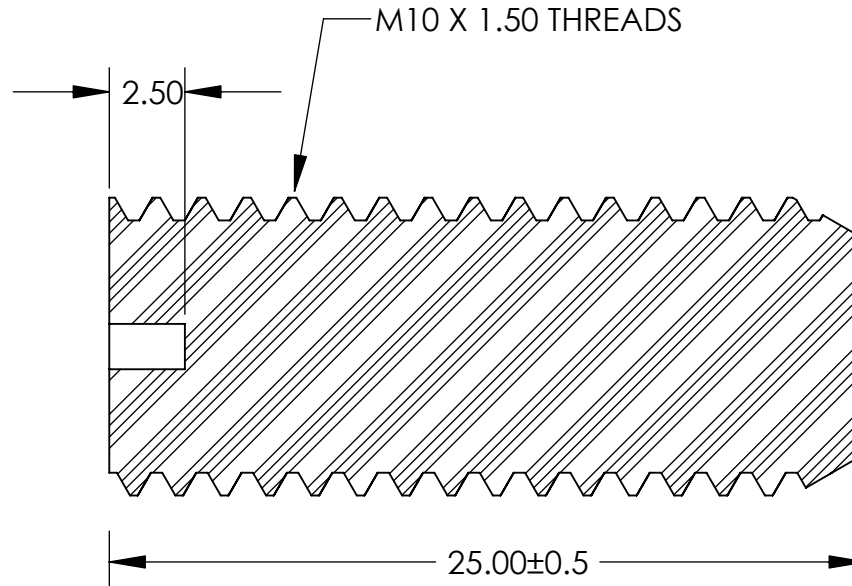
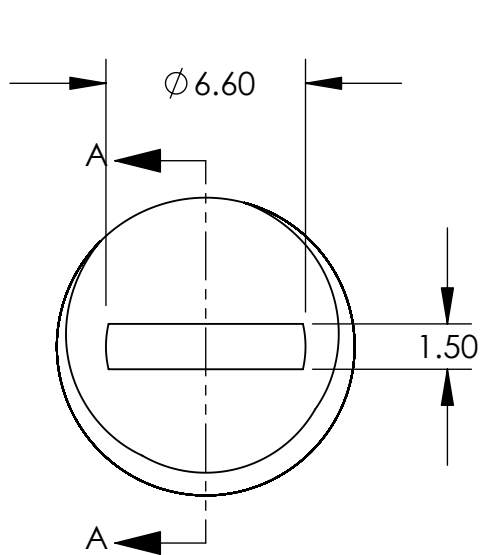

SECTION A-A

ALL DIMENSIONS ARE IN MILLIMETERS
TOLERANCES UNLESS NOTED

- $\pm .13$ MM ON DIMENSIONS THRU 15.88MM
- $\pm .20$ MM ON DIMENSIONS 15.89MM THRU 25.41MM
- $\pm .25$ MM ON DIMENSIONS 25.42MM THRU 38.10MM
- $\pm .38$ MM ON DIMENSIONS LARGER THAN 38.10MM

WE RESERVE THE RIGHT
 TO DISCONTINUE ITEMS,
 CHANGE SPECIFICATIONS
 OR DESIGN AT ANY TIME
 WITHOUT NOTICE AND
 WITHOUT INCURRING
 ANY OBLIGATIONS

PROPERTY OF		
MICRO PLASTICS INC.		
CATALOG DRAWING GRUB SLOTTED MACHINE SCREW MICRO P/N 50M100150R025 DWG. # 50M100150R025 FILE SERVER\ENG\WEB		
MATERIAL:		6/6 NYLON
DATE	SCALE	TA
	4:1	