

UNCONTROLLED DOCUMENT

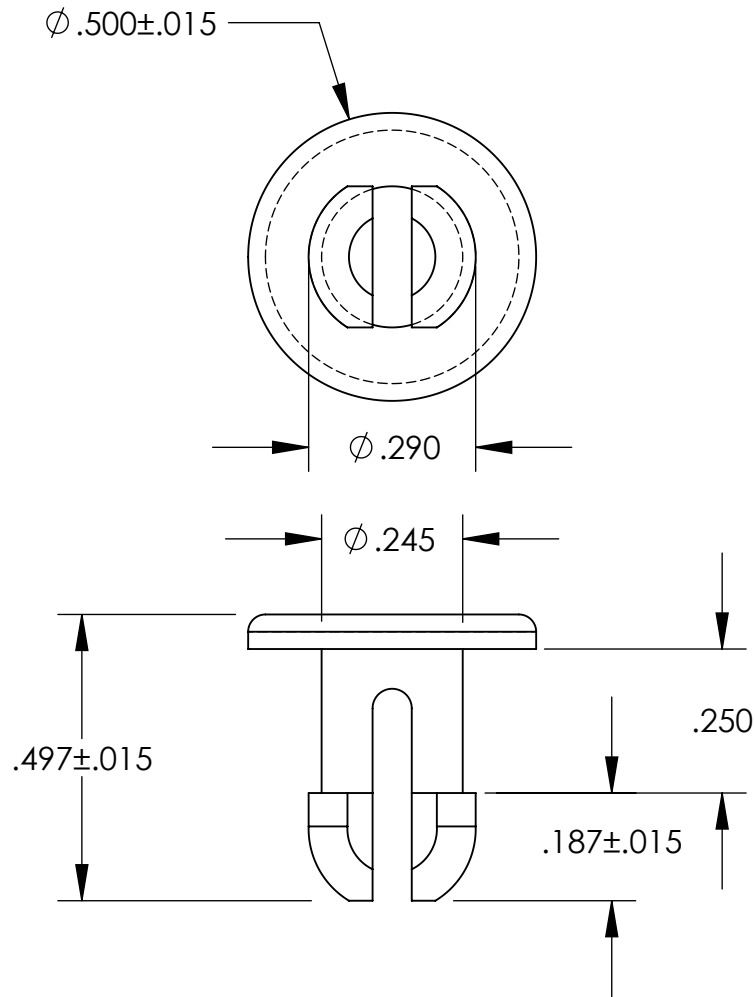

TOLERANCES UNLESS NOTED

- $\pm .005$  ON DIMENSIONS THRU  $.625$
- $\pm .008$  ON DIMENSIONS  $.626$  THRU  $1.000$
- $\pm .010$  ON DIMENSIONS  $1.001$  THRU  $1.500$
- $\pm .015$  ON DIMENSIONS LARGER THAN  $1.500$
- $\pm .015$  ON FRACTIONAL DIMENSIONS

WE RESERVE THE RIGHT  
TO DISCONTINUE ITEMS,  
CHANGE SPECIFICATIONS  
OR DESIGN AT ANY TIME  
WITHOUT NOTICE AND  
WITHOUT INCURRING  
ANY OBLIGATIONS

PROPERTY OF  
**MICRO PLASTICS INC.**

CATALOG DRAWING  
PUSH-IN FASTENER  
MICRO P/N 27PIF0118  
DWG. # 27PIF0118  
FILE SERVER\ENG\WEB

MATERIAL: NYLON 6/6

DATE

SCALE  
3:1

**TA**