

**UNCONTROLLED DOCUMENT**

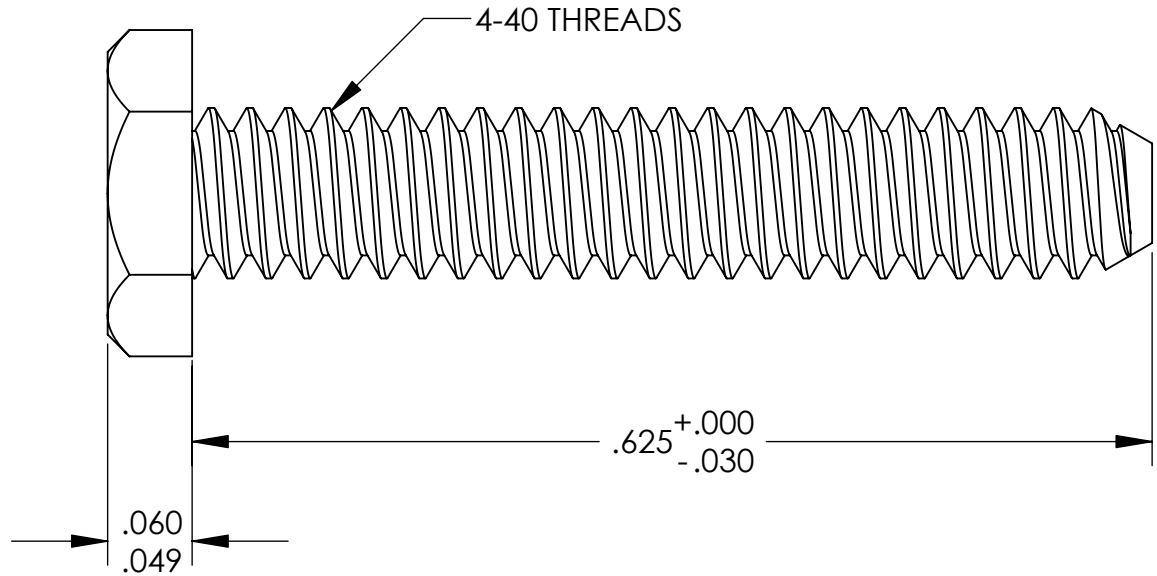
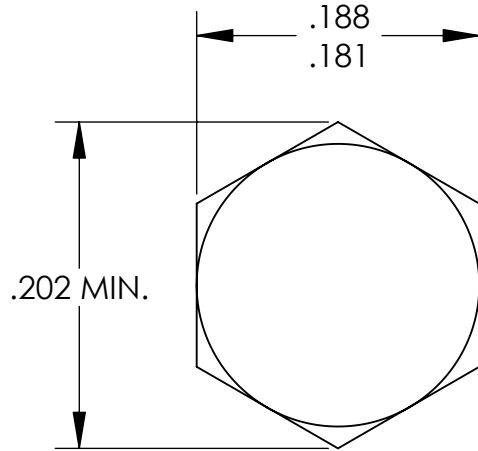

**TOLERANCES UNLESS NOTED**

- ±.005 ON DIMENSIONS THRU .625
- ±.008 ON DIMENSIONS .626 THRU 1.000
- ±.010 ON DIMENSIONS 1.001 THRU 1.500
- ±.015 ON DIMENSIONS LARGER THAN 1.500
- ±.015 ON FRACTIONAL DIMENSIONS

**WE RESERVE THE RIGHT TO DISCONTINUE ITEMS, CHANGE SPECIFICATIONS OR DESIGN AT ANY TIME WITHOUT NOTICE AND WITHOUT INCURRING ANY OBLIGATIONS**

PROPERTY OF  
**MICRO PLASTICS INC.**

CATALOG DRAWING  
HEX UNSLOTTED MACHINE SCREW  
MICRO P/N 010440H062  
DWG. # 010440H062  
FILE SERVER\ENG\WEB

**MATERIAL:** 6/6 NYLON

DATE

SCALE  
8:1

**JDD**