

**UNCONTROLLED DOCUMENT**

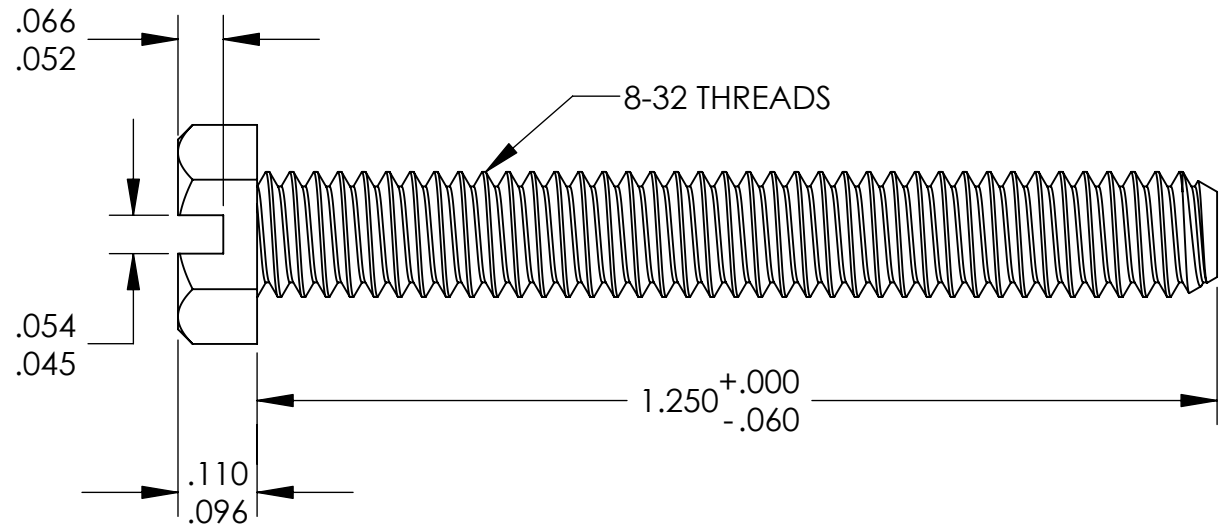
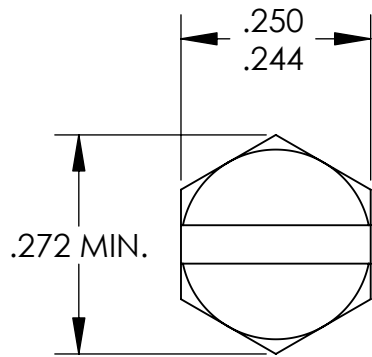

**TOLERANCES UNLESS NOTED**

- ±.005 ON DIMENSIONS THRU .625
- ±.008 ON DIMENSIONS .626 THRU 1.000
- ±.010 ON DIMENSIONS 1.001 THRU 1.500
- ±.015 ON DIMENSIONS LARGER THAN 1.500
- ±.015 ON FRACTIONAL DIMENSIONS

**WE RESERVE THE RIGHT TO DISCONTINUE ITEMS, CHANGE SPECIFICATIONS OR DESIGN AT ANY TIME WITHOUT NOTICE AND WITHOUT INCURRING ANY OBLIGATIONS**

PROPERTY OF		
<b>MICRO PLASTICS INC.</b>		
CATALOG DRAWING HEX SLOTTED MACHINE SCREW MICRO P/N 010832X125 DWG. # 010832X125 FILE SERVER\ENG\WEB		
MATERIAL:		6/6 NYLON
DATE	SCALE	<b>JDD</b>
	4:1	