

**UNCONTROLLED DOCUMENT**

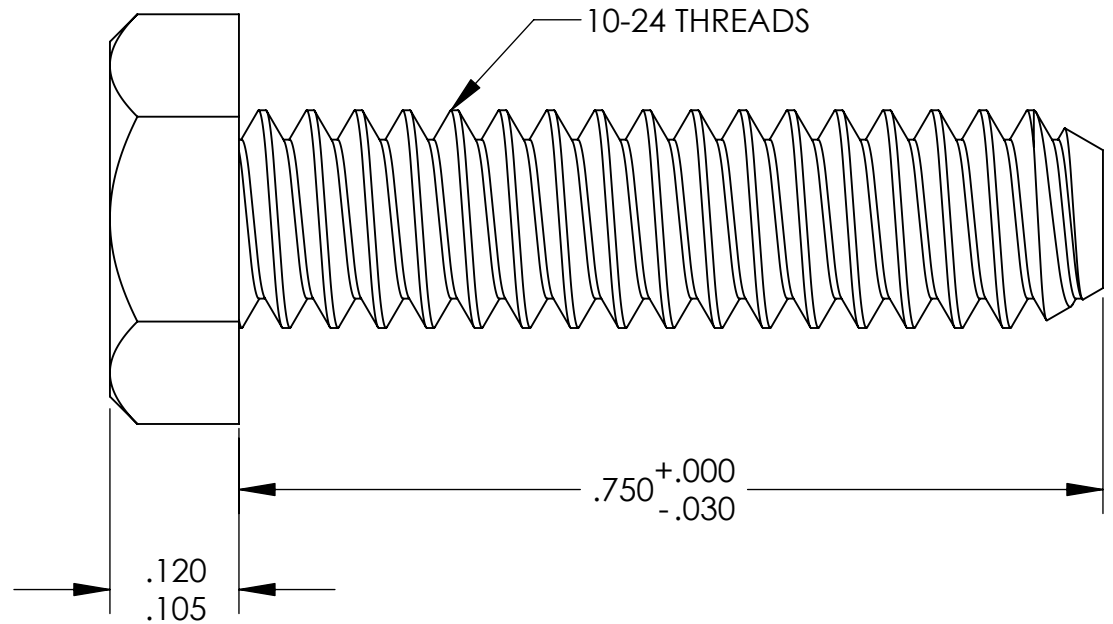
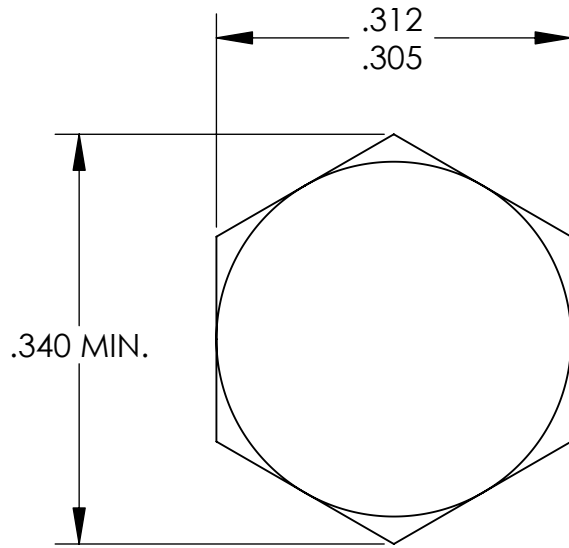

**TOLERANCES UNLESS NOTED**

- $\pm .005$  ON DIMENSIONS THRU .625
- $\pm .008$  ON DIMENSIONS .626 THRU 1.000
- $\pm .010$  ON DIMENSIONS 1.001 THRU 1.500
- $\pm .015$  ON DIMENSIONS LARGER THAN 1.500
- $\pm .015$  ON FRACTIONAL DIMENSIONS

**WE RESERVE THE RIGHT TO DISCONTINUE ITEMS, CHANGE SPECIFICATIONS OR DESIGN AT ANY TIME WITHOUT NOTICE AND WITHOUT INCURRING ANY OBLIGATIONS**

PROPERTY OF  
**MICRO PLASTICS INC.**

CATALOG DRAWING  
HEX UNSLOTTED MACHINE SCREW  
MICRO P/N 011024H075  
DWG. # 011024H075  
FILE SERVER\ENG\WEB

**MATERIAL:** 6/6 NYLON

DATE

SCALE  
6:1

**JDD**