

UNCONTROLLED DOCUMENT

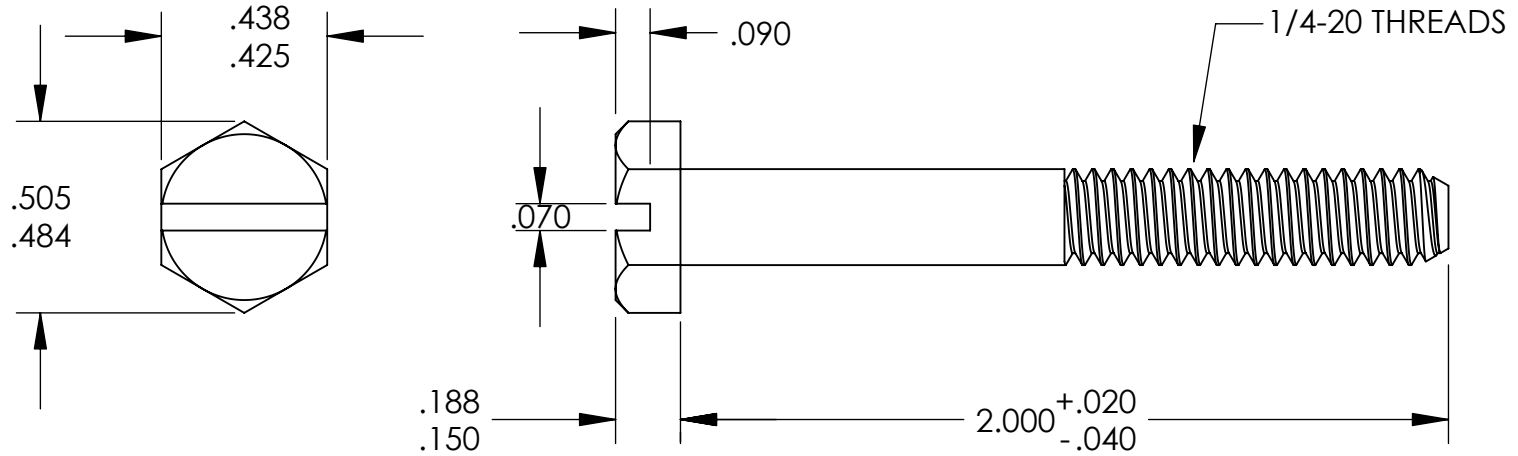

TOLERANCES UNLESS NOTED

- ±.005 ON DIMENSIONS THRU .625
- ±.008 ON DIMENSIONS .626 THRU 1.000
- ±.010 ON DIMENSIONS 1.001 THRU 1.500
- ±.015 ON DIMENSIONS LARGER THAN 1.500
- ±.015 ON FRACTIONAL DIMENSIONS

WE RESERVE THE RIGHT  
TO DISCONTINUE ITEMS,  
CHANGE SPECIFICATIONS  
OR DESIGN AT ANY TIME  
WITHOUT NOTICE AND  
WITHOUT INCURRING  
ANY OBLIGATIONS

PROPERTY OF  
**MICRO PLASTICS INC.**

CATALOG DRAWING  
SLOTTED HEX CAP SCREW  
MICRO P/N 3225020200  
DWG. # 3225020200  
FILE SERVER\ENG\WEB

MATERIAL: 6/6 NYLON

DATE

SCALE  
2:1

*JDD*