

UNCONTROLLED DOCUMENT

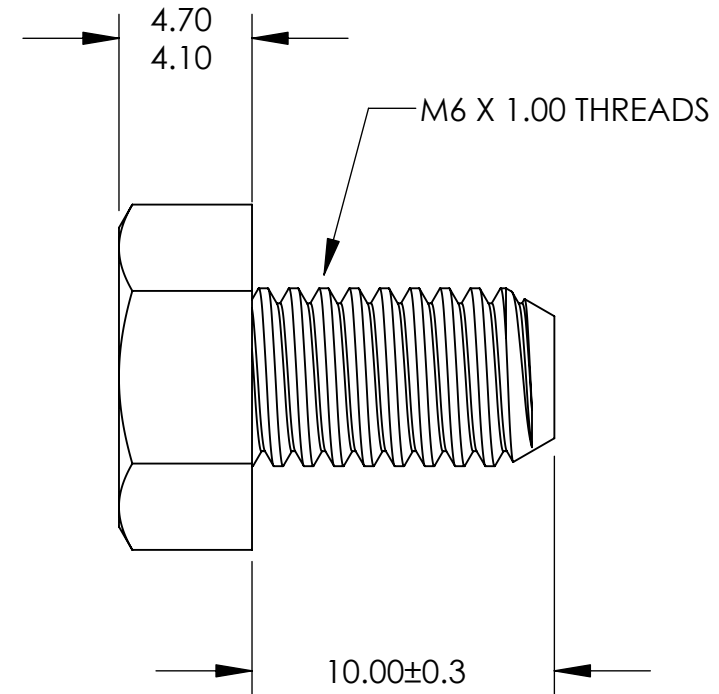
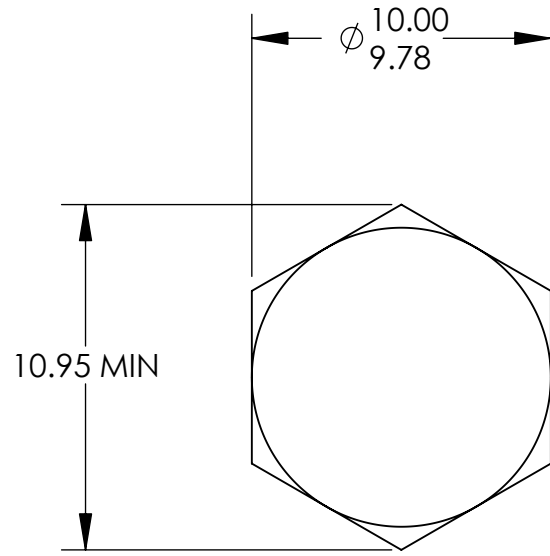

ALL DIMENSIONS ARE IN MILLIMETERS
TOLERANCES UNLESS NOTED

- ±.13MM ON DIMENSIONS THRU 15.88MM
- ±.20MM ON DIMENSIONS 15.89MM THRU 25.41MM
- ±.25MM ON DIMENSIONS 25.42MM THRU 38.10MM
- ±.38MM ON DIMENSIONS LARGER THAN 38.10MM

WE RESERVE THE RIGHT
 TO DISCONTINUE ITEMS,
 CHANGE SPECIFICATIONS
 OR DESIGN AT ANY TIME
 WITHOUT NOTICE AND
 WITHOUT INCURRING
 ANY OBLIGATIONS

PROPERTY OF		
MICRO PLASTICS INC.		
CATALOG DRAWING HEX UNSLOTTED MACHINE SCREW MICRO P/N 50M060100J010 DWG. # 50M060100J010 FILE SERVER\ENG\WEB		
MATERIAL:		6/6 NYLON
DATE	SCALE	TA
	4:1	