

UNCONTROLLED DOCUMENT

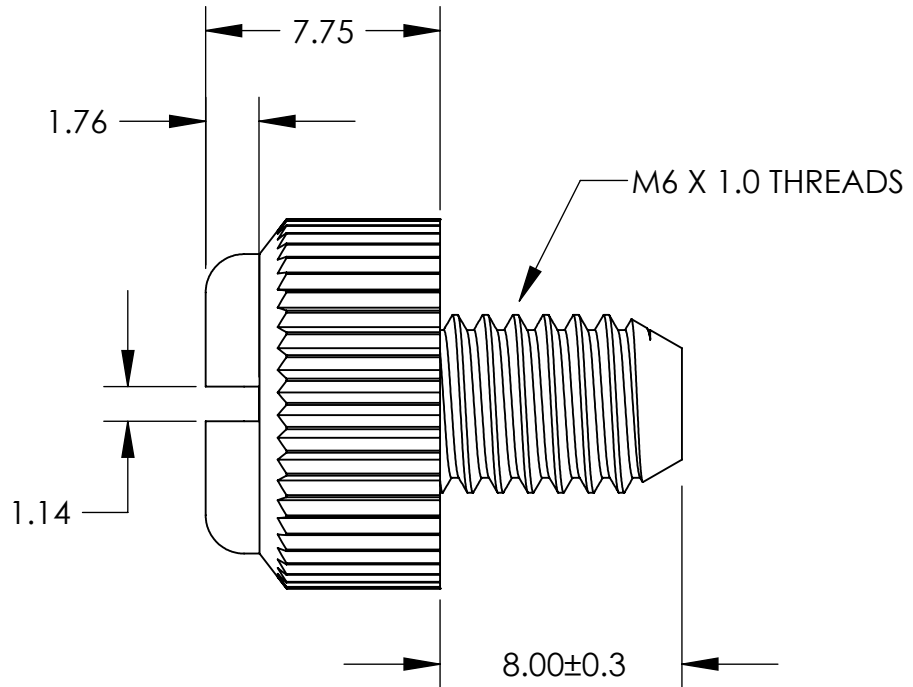
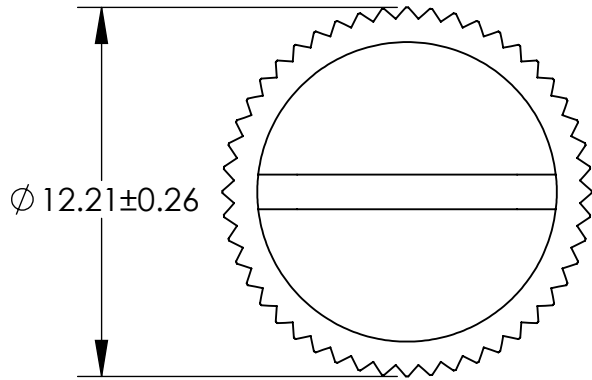

ALL DIMENSIONS ARE IN MILLIMETERS  
TOLERANCES UNLESS NOTED

- ±.13MM ON DIMENSIONS THRU 15.88MM
- ±.20MM ON DIMENSIONS 15.89MM THRU 25.41MM
- ±.25MM ON DIMENSIONS 25.42MM THRU 38.10MM
- ±.38MM ON DIMENSIONS LARGER THAN 38.10MM

WE RESERVE THE RIGHT  
TO DISCONTINUE ITEMS,  
CHANGE SPECIFICATIONS  
OR DESIGN AT ANY TIME  
WITHOUT NOTICE AND  
WITHOUT INCURRING  
ANY OBLIGATIONS

PROPERTY OF  
**MICRO PLASTICS INC.**

CATALOG DRAWING  
ECONOMY GRADE THUMB SCREW  
MICRO P/N 50M060100T008  
DWG. # 50M060100T008  
FILE SERVER\ENG\WEB

MATERIAL: 6/6 NYLON

DATE

SCALE  
4:1

**TA**