

UNCONTROLLED DOCUMENT

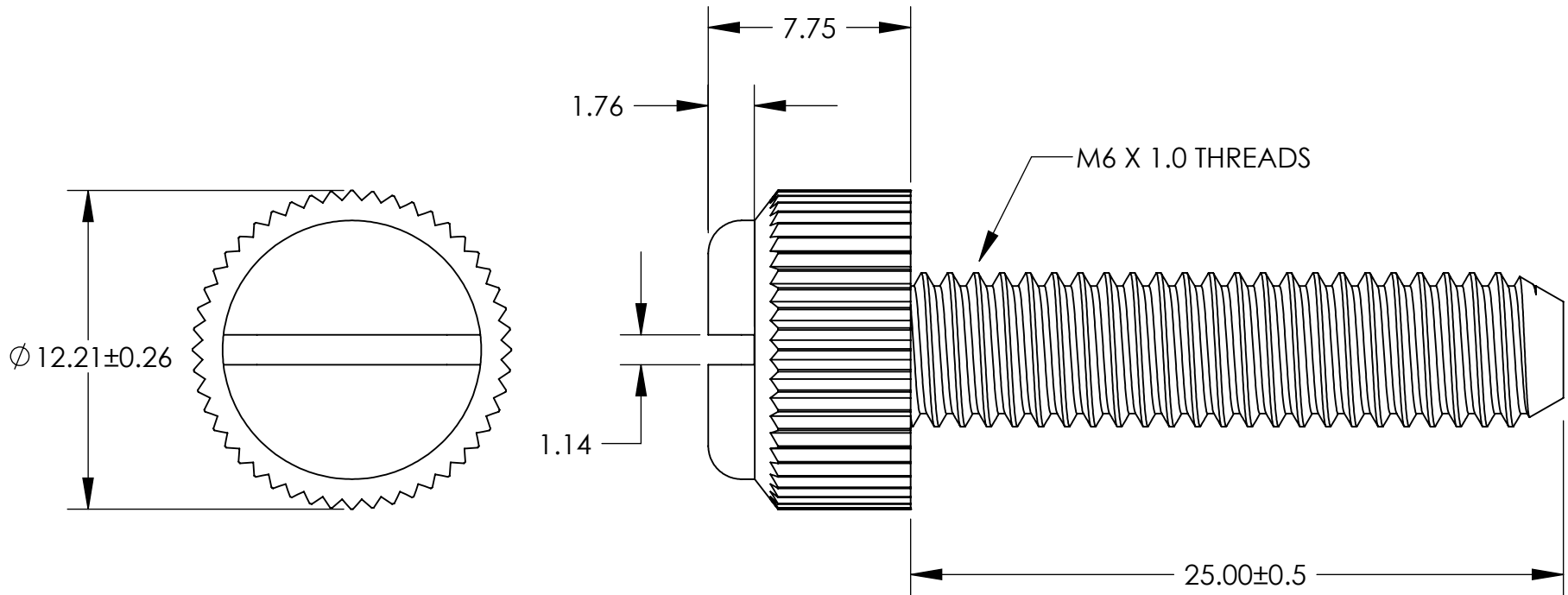

ALL DIMENSIONS ARE IN MILLIMETERS
TOLERANCES UNLESS NOTED

- $\pm .13$ MM ON DIMENSIONS THRU 15.88MM
- $\pm .20$ MM ON DIMENSIONS 15.89MM THRU 25.41MM
- $\pm .25$ MM ON DIMENSIONS 25.42MM THRU 38.10MM
- $\pm .38$ MM ON DIMENSIONS LARGER THAN 38.10MM

WE RESERVE THE RIGHT
 TO DISCONTINUE ITEMS,
 CHANGE SPECIFICATIONS
 OR DESIGN AT ANY TIME
 WITHOUT NOTICE AND
 WITHOUT INCURRING
 ANY OBLIGATIONS

PROPERTY OF
MICRO PLASTICS INC.

CATALOG DRAWING
 ECONOMY GRADE THUMB SCREW
 MICRO P/N 50M060100T025
 DWG. # 50M060100T025
 FILE SERVER\ENG\WEB

MATERIAL: 6/6 NYLON

DATE

SCALE
 4:1

TA