

**UNCONTROLLED DOCUMENT**

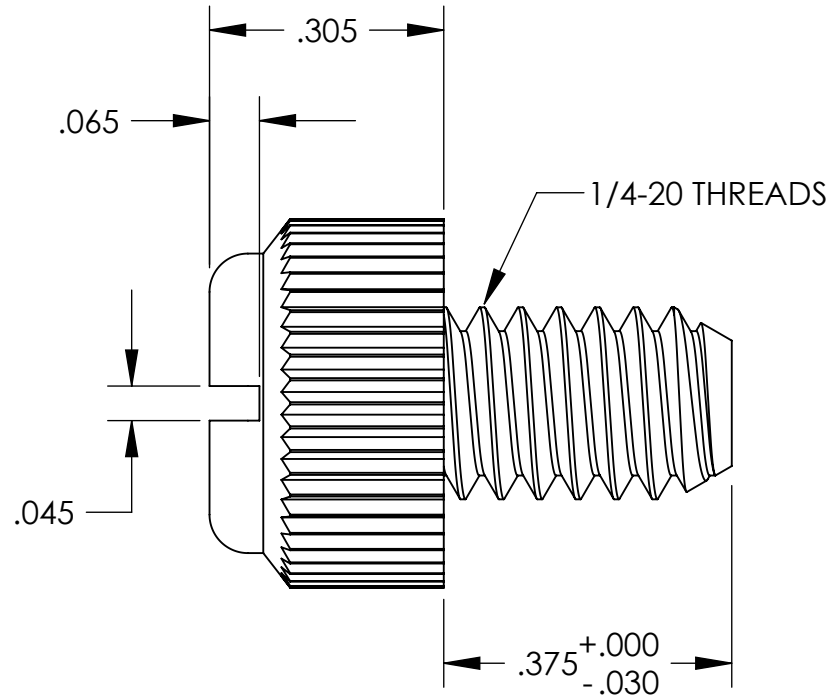
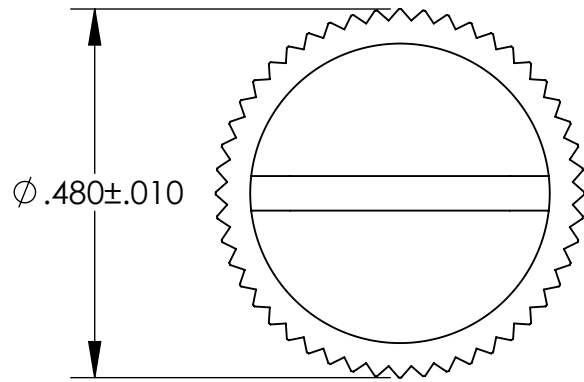

**TOLERANCES UNLESS NOTED**

- $\pm .005$  ON DIMENSIONS THRU .625
- $\pm .008$  ON DIMENSIONS .626 THRU 1.000
- $\pm .010$  ON DIMENSIONS 1.001 THRU 1.500
- $\pm .015$  ON DIMENSIONS LARGER THAN 1.500
- $\pm .015$  ON FRACTIONAL DIMENSIONS

**WE RESERVE THE RIGHT  
TO DISCONTINUE ITEMS,  
CHANGE SPECIFICATIONS  
OR DESIGN AT ANY TIME  
WITHOUT NOTICE AND  
WITHOUT INCURRING  
ANY OBLIGATIONS**

PROPERTY OF  
**MICRO PLASTICS INC.**

CATALOG DRAWING  
ECONOMY GRADE THUMB SCREW  
MICRO P/N 092520037TEG  
DWG. # 092520037TEG  
FILE SERVER\ENG\WEB

**MATERIAL:** 6/6 NYLON

DATE

SCALE  
4:1

**JDD**