

# UNCONTROLLED DOCUMENT

NOTE:  
FOR VERY LIGHT DUTY APPLICATION.

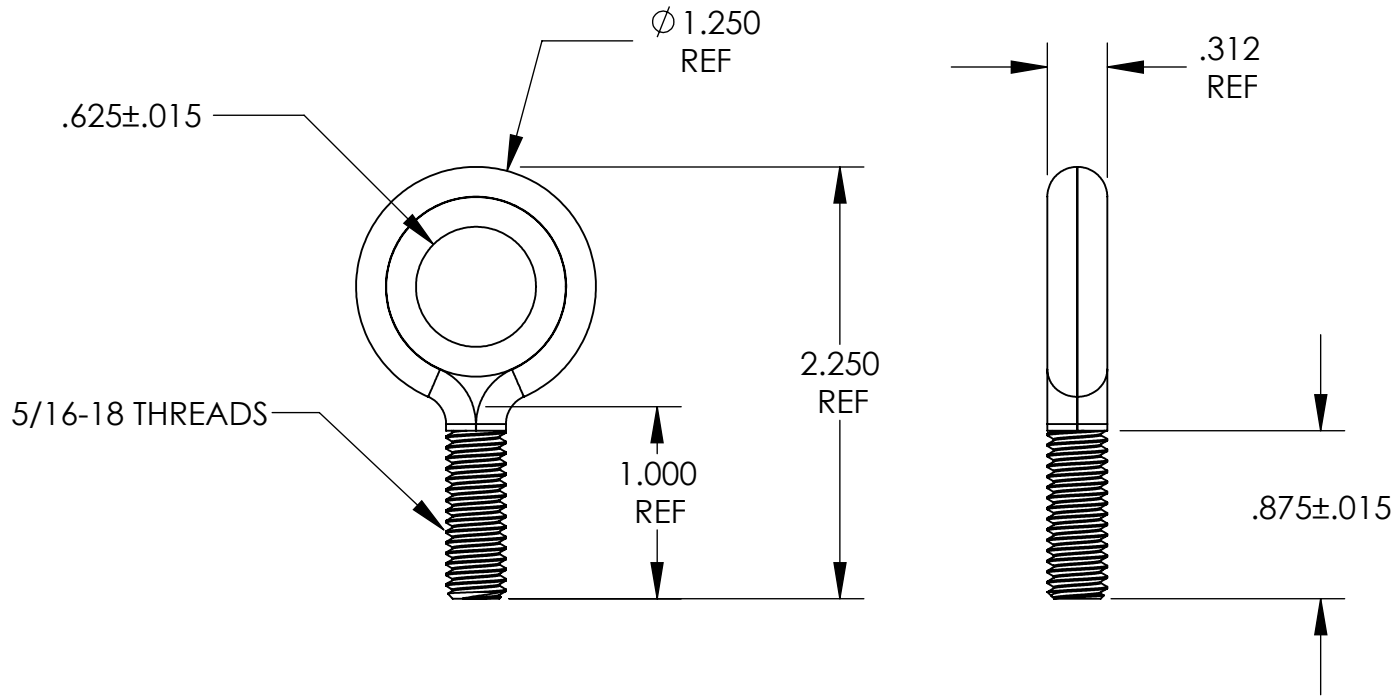

### TOLERANCES UNLESS NOTED

- $\pm .005$  ON DIMENSIONS THRU  $.625$
- $\pm .008$  ON DIMENSIONS  $.626$  THRU  $1.000$
- $\pm .010$  ON DIMENSIONS  $1.001$  THRU  $1.500$
- $\pm .015$  ON DIMENSIONS LARGER THAN  $1.500$
- $\pm .015$  ON FRACTIONAL DIMENSIONS

WE RESERVE THE RIGHT  
TO DISCONTINUE ITEMS,  
CHANGE SPECIFICATIONS  
OR DESIGN AT ANY TIME  
WITHOUT NOTICE AND  
WITHOUT INCURRING  
ANY OBLIGATIONS

PROPERTY OF		
<b>MICRO PLASTICS INC.</b>		
CATALOG DRAWING EYE BOLT MICRO P/N 0131218EYEB100 DWG. # 0131218EYEB100 FILE SERVER\ENG\WEB		
MATERIAL:		NYLON 6/6
DATE	SCALE 1:1	<b>TA</b>