

UNCONTROLLED DOCUMENT

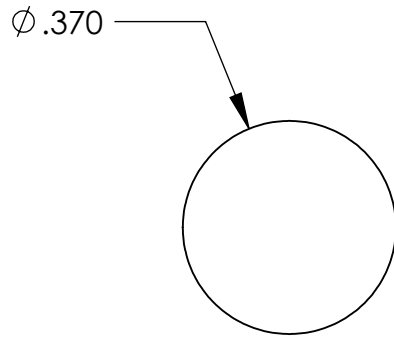

NOTES:
HOLE SIZE - .182 / .192
PANEL THICKNESS - .310 / .330

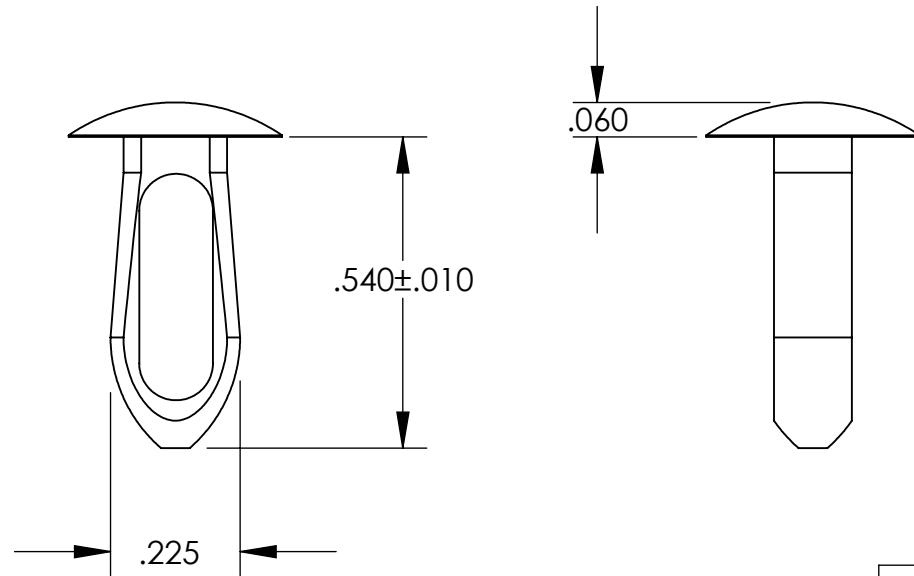

TOLERANCES UNLESS NOTED

- ±.005 ON DIMENSIONS THRU .625
- ±.008 ON DIMENSIONS .626 THRU 1.000
- ±.010 ON DIMENSIONS 1.001 THRU 1.500
- ±.015 ON DIMENSIONS LARGER THAN 1.500
- ±.015 ON FRACTIONAL DIMENSIONS

WE RESERVE THE RIGHT
TO DISCONTINUE ITEMS,
CHANGE SPECIFICATIONS
OR DESIGN AT ANY TIME
WITHOUT NOTICE AND
WITHOUT INCURRING
ANY OBLIGATIONS

PROPERTY OF		
MICRO PLASTICS INC.		
CATALOG DRAWING ARROW CLIP MICRO P/N 27AC0006 DWG. # 27AC0006 FILE SERVER\ENG\WEB		
MATERIAL:		NYLON 6/6
DATE	SCALE	TA
	3:1	